

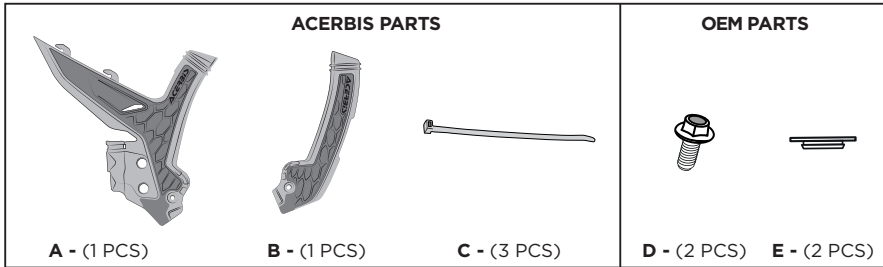

## X-GRIP FRAME GUARD KTM SX/SX-F 23

### PARATELAIO X-GRIP KTM SX/SX-F 23

COD. 500008640



**WARNING**



ATTENZIONE: Si consiglia vivamente di rimuovere periodicamente il prodotto per la pulizia e la manutenzione.



ATTENTION: Highly recommended to remove product periodically for cleaning maintenance.

**1**

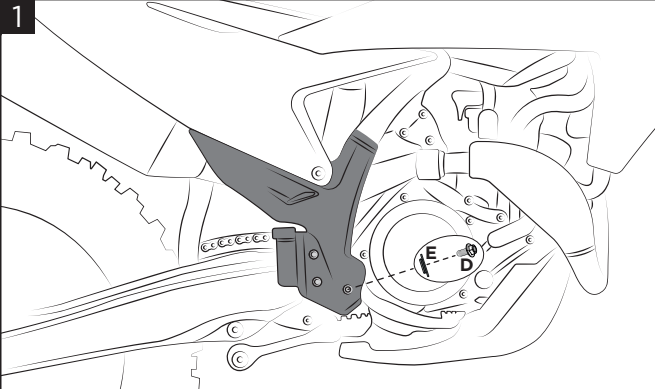

**Remove the original cover by loosening the bushing (E) and the screw (D).**  
Rimuovere la cover originale svitando la boccola (E) e la vite (D).

**2**

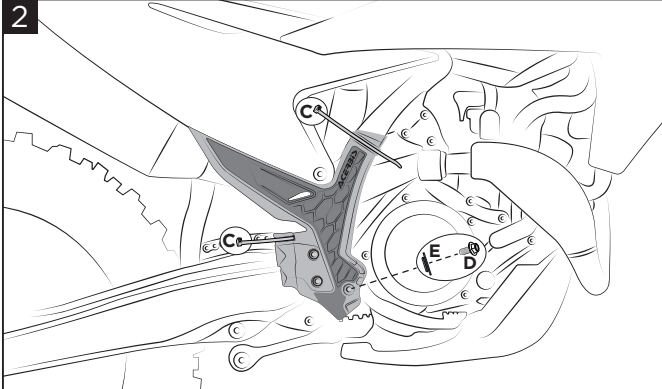

**Mount the Acerbis X-Grip (A) using the bushing (E) and screw (D) original and tighten it using the clamps (C).**  
Montare l'X-Grip Acerbis (A) riutilizzando la boccola (E) e la vite (D) originali e fissarlo tramite le fascette (C).

**3**

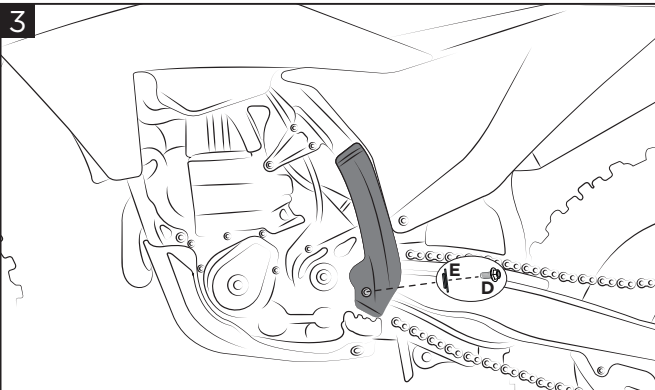

**Remove the original cover by loosening the bushing (E) and the screw (D).**  
Rimuovere la cover originale svitando la boccola (E) e la vite (D).

**4**

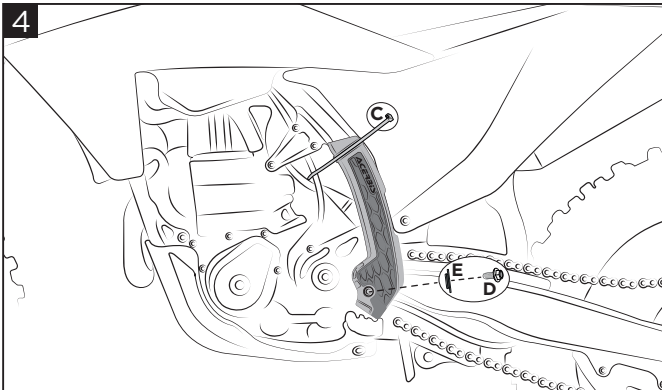

**Mount the Acerbis X-Grip (A) using the bushing (E) and screw (D) original and tighten it using the clamp (C).**  
Montare l'X-Grip Acerbis (A) riutilizzando la boccola (E) e la vite (D) originali e fissarlo tramite la fascetta (C).

### WARNING!

Use Acerbis' products at your own risk. Check the safety of your device before you ride. Be sure that you follow the instructions for installing the Acerbis' products. Do not ride if there is missing or damaged hardware. If this is the case, take the item immediately back to your dealer. Make sure the throttle and other controls are free every time you ride. Not following these instructions and warnings could lead to interference with the controls, loss of control, and accidents. Acerbis recommends that installation must be done by a licensed mechanic and that only Acerbis' original parts are used during installation. Acerbis makes no guarantees or representations, express or implied, regarding the fitment of its product for any particular purpose. Acerbis makes no guarantees or representations, express or implied, regarding the extent to which its products protect individuals or property from injury or death or damage.

#### EUROPE

ACERBIS ITALIA S.P.A.  
VIA SERIO, 37  
24021 ALBINO (BG)  
ITALY

#### U.S.A.

ACERBIS U.S.A. INC.  
MAIL P.O. BOX 2030  
SUN VALLEY, ID 83353  
SHIP 110 LINDAY CIRCLE  
KETCHUM, ID 83340  
U.S.A.

#### UNITED KINGDOM

ACERBIS U.K LTD  
UNIT 2 LUTON ENTERPRISE PARK  
SUNDON PARK ROAD  
LUTON, BEDFORDSHIRE LU3 3GU  
GREAT BRITAIN